

① changes

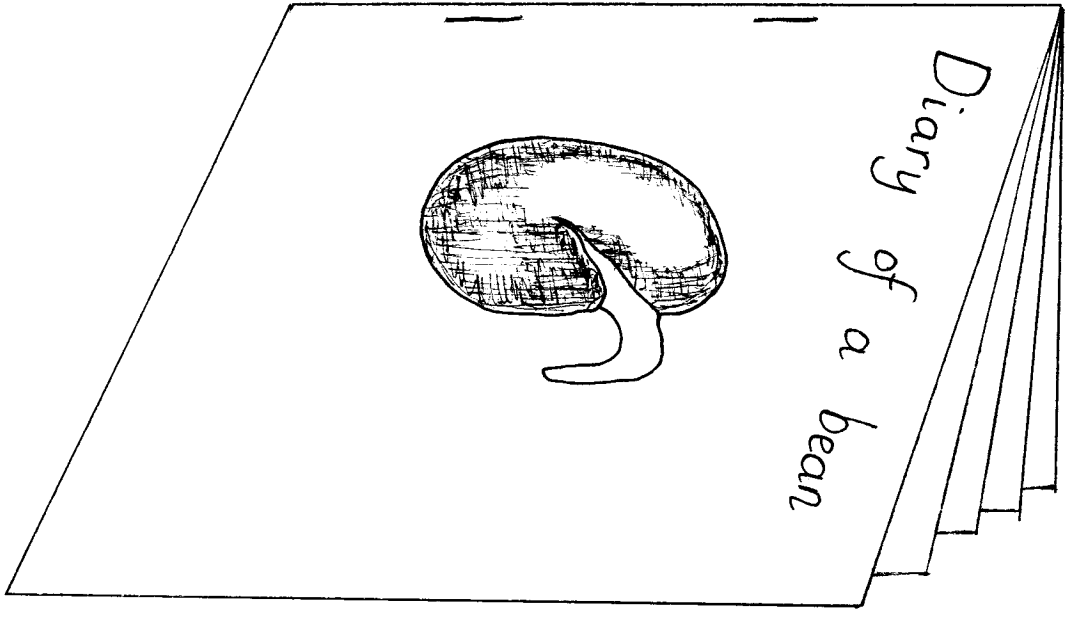

How many hand spans?

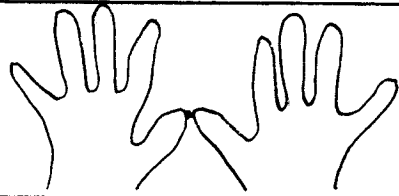

The width of the table.	
The length of the door.	
The height of a chair.	
The width of the white board	
The length of a book	
The height of your friend	
The width of a display board	
Your ruler	



How many footprints ?

The width of
the classroom.

The length of
the hall.

The width of
the playground.

The length of
the corridor.

The width of
the path.

The height of a
fence.

The width of a
picnic table.

The length of
a bench.

Number of children

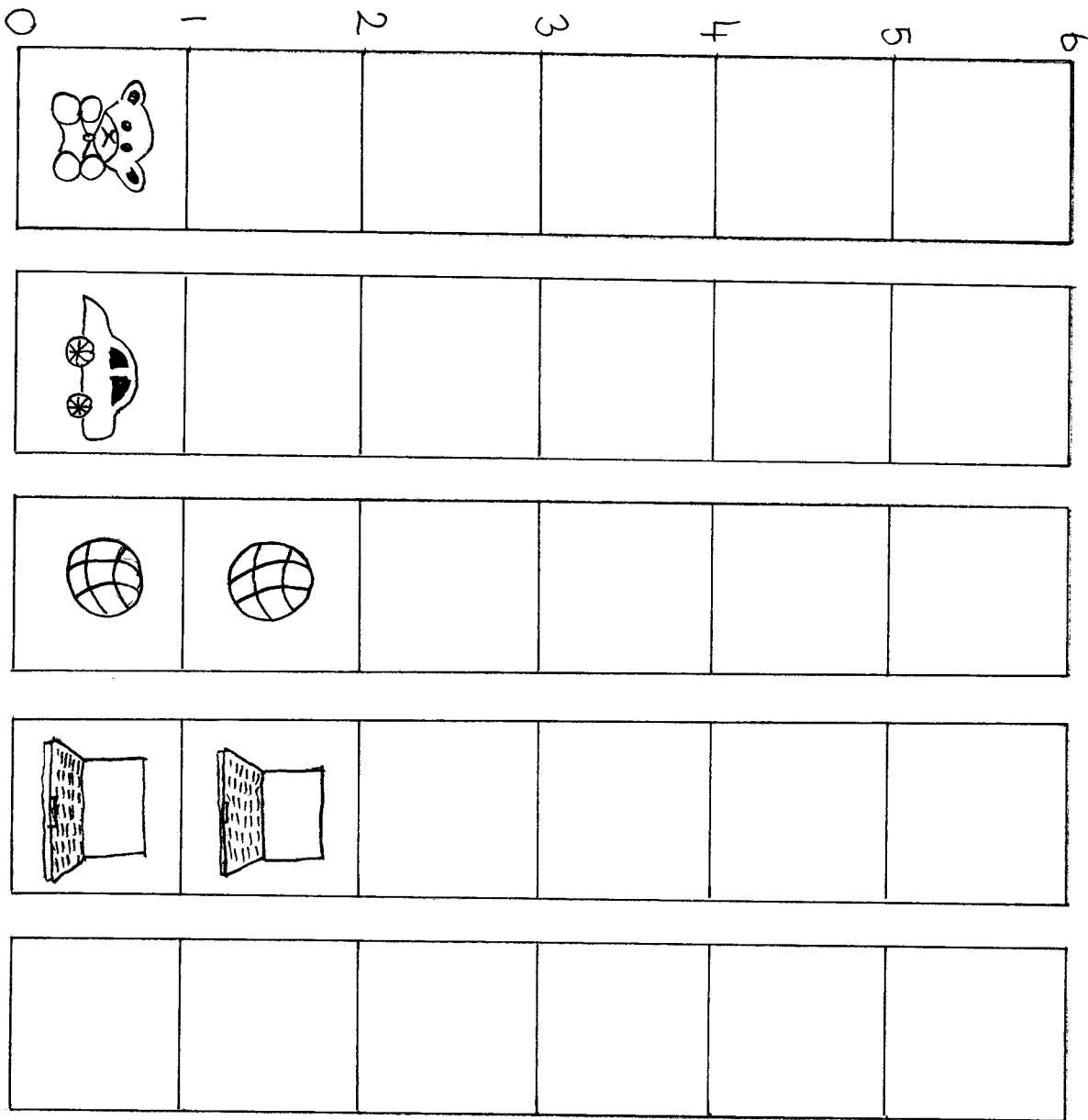

Our favourite toys

Changes

④

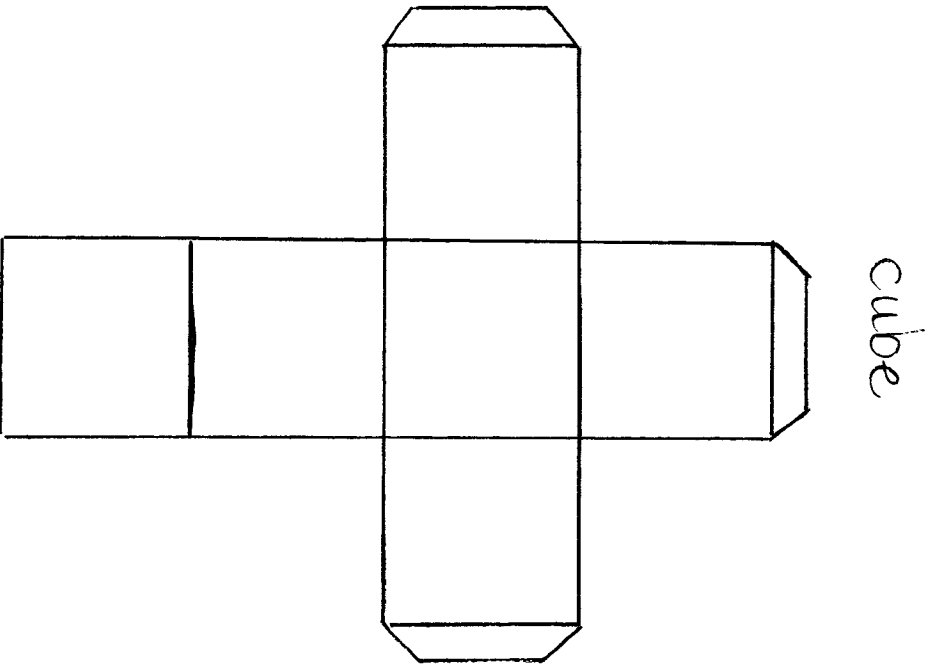

cube

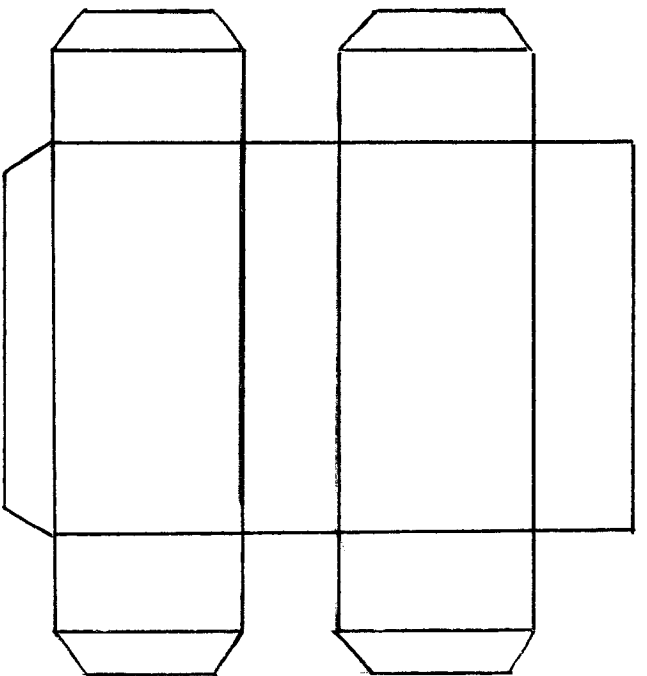

cuboid

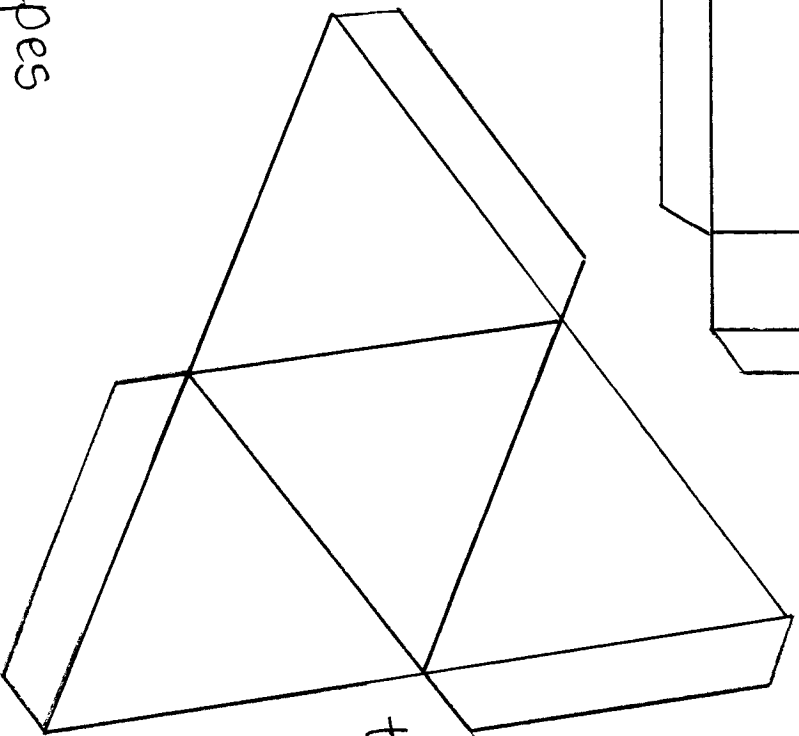

tetrahedron

Nets of shapes

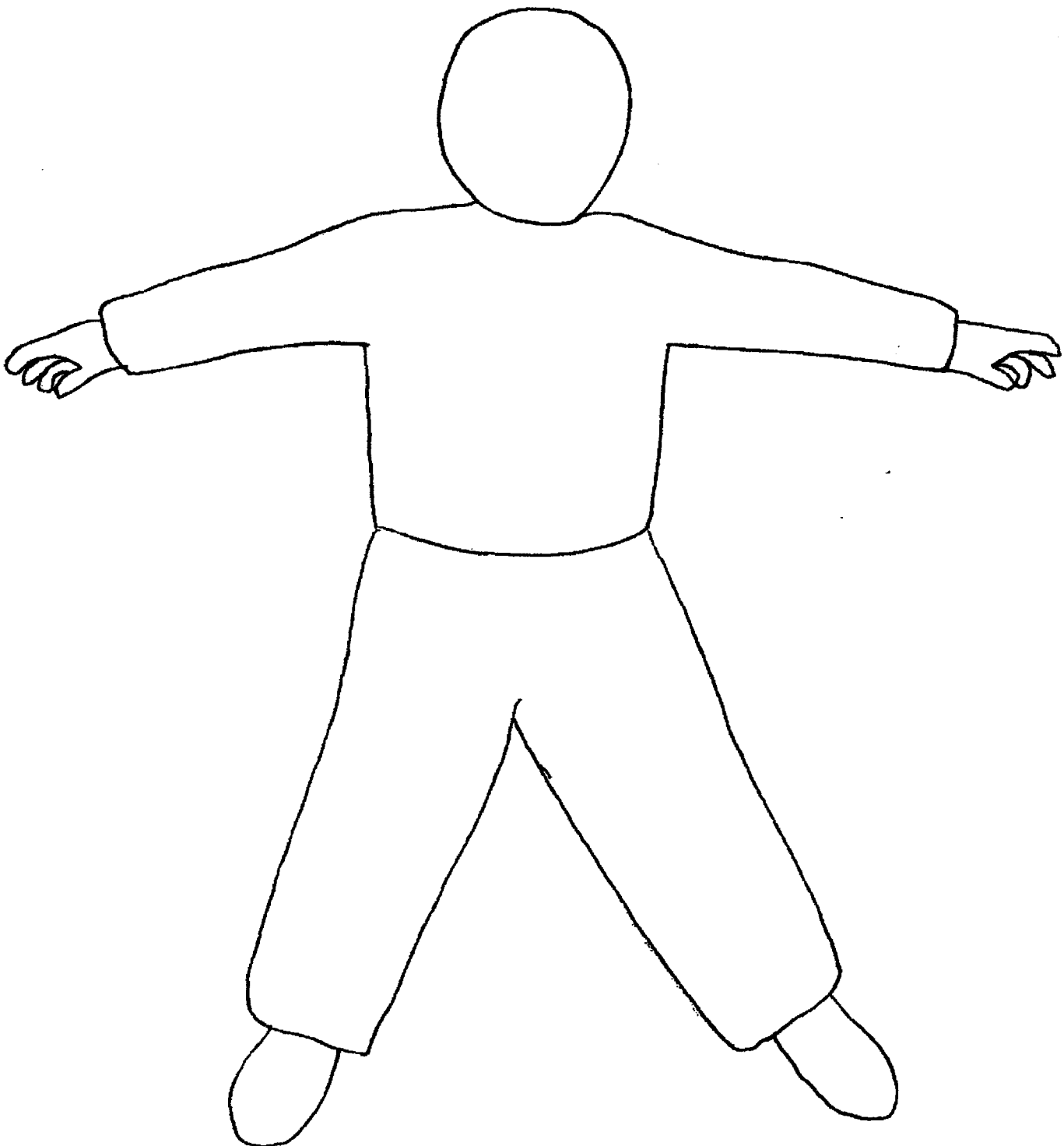

	Hot water. ☕ Does it dissolve?	Cold water. ☕ Does it dissolve ?	What have you discovered ?
coffee granules			
salt			
sugar			
sand			

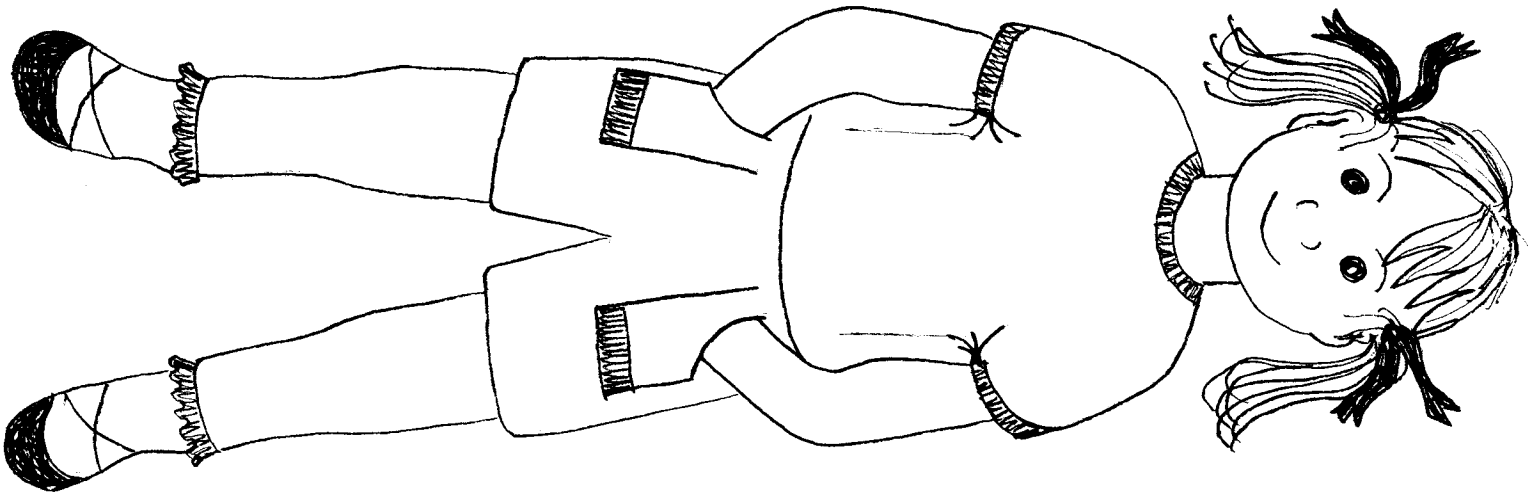
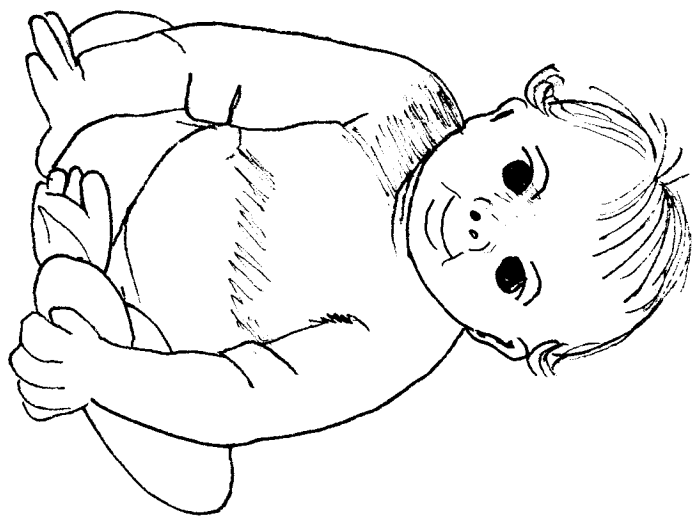

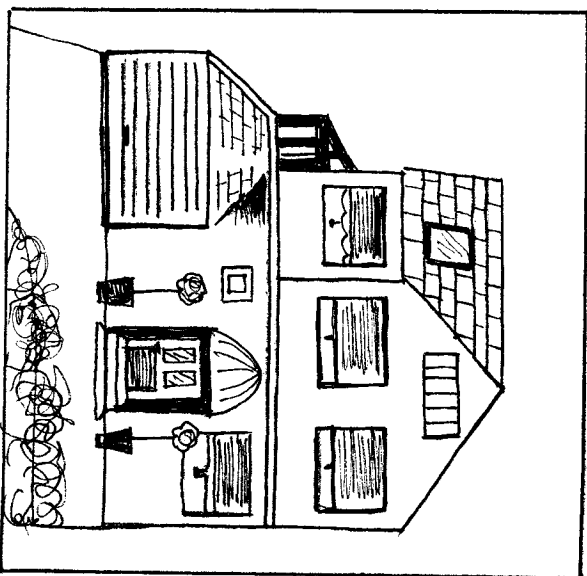
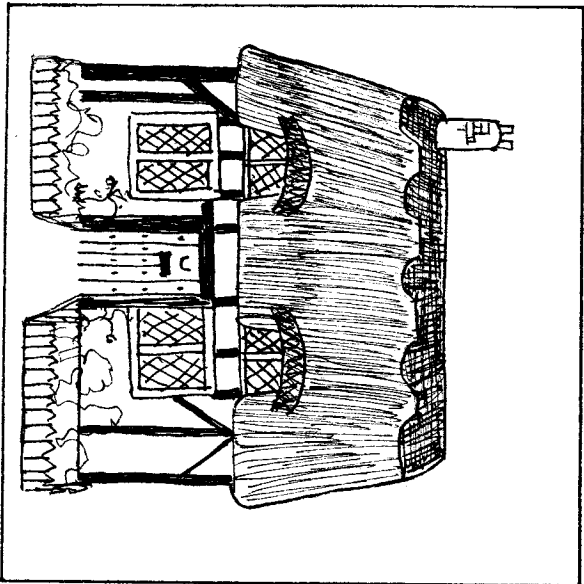
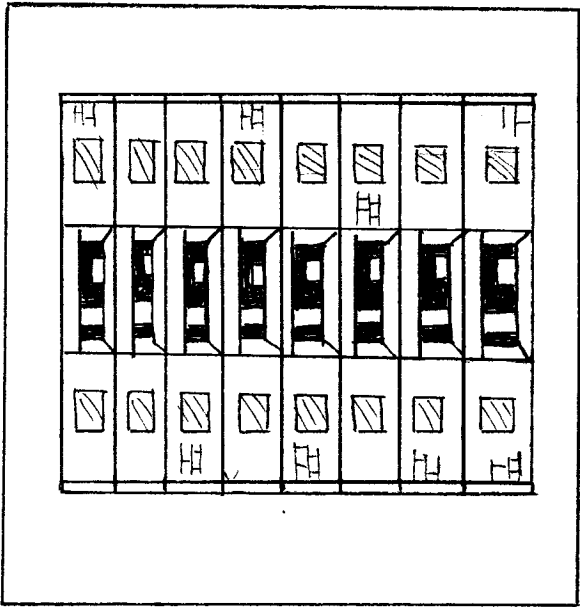
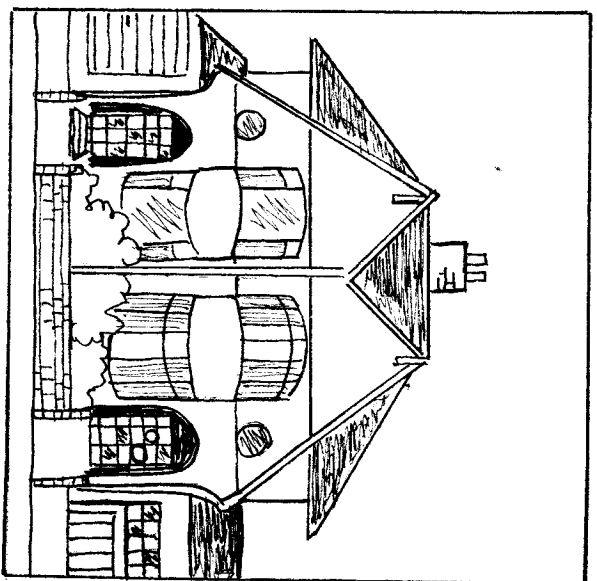
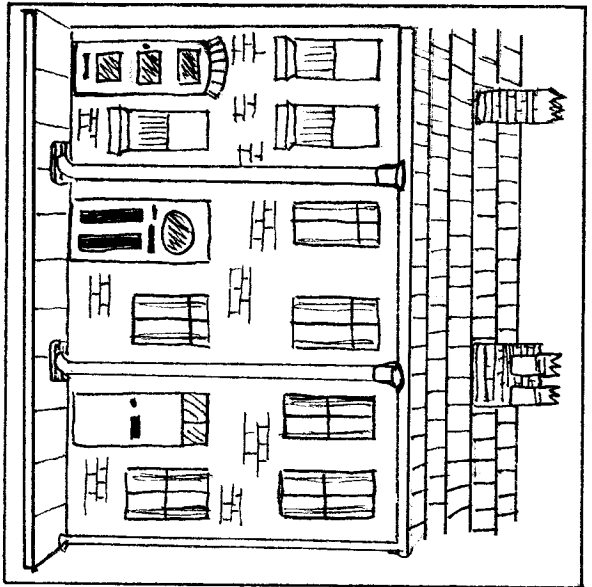
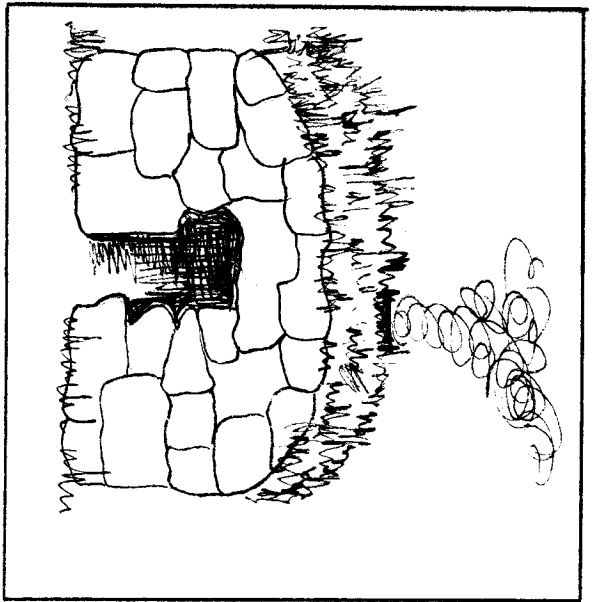

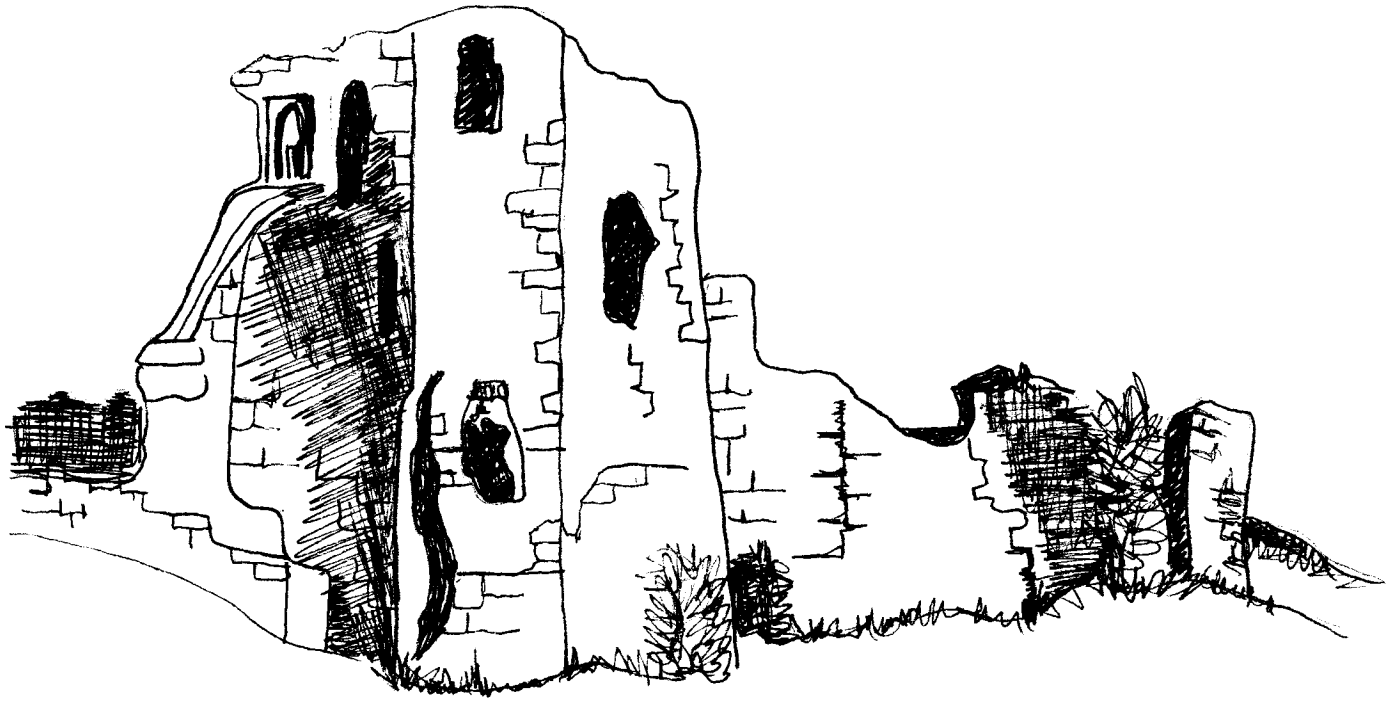

Charges (10)

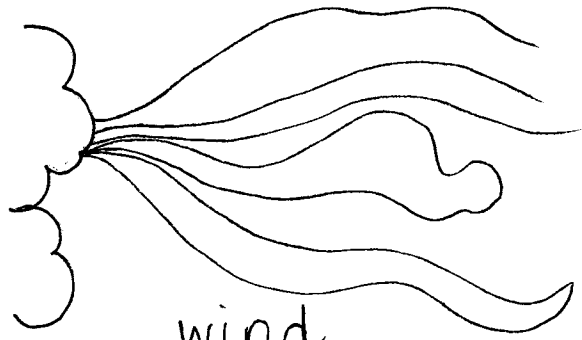

wind

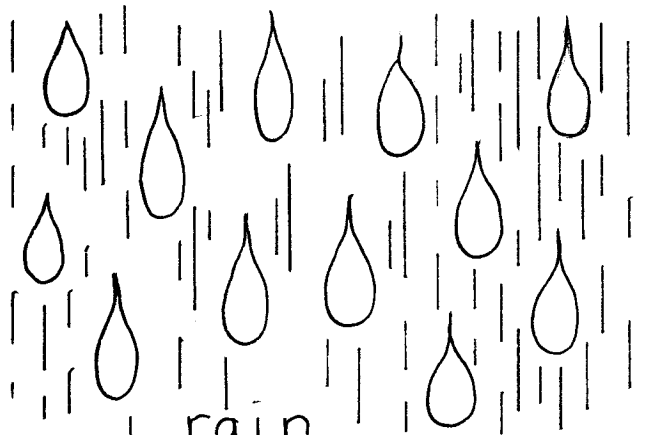

rain

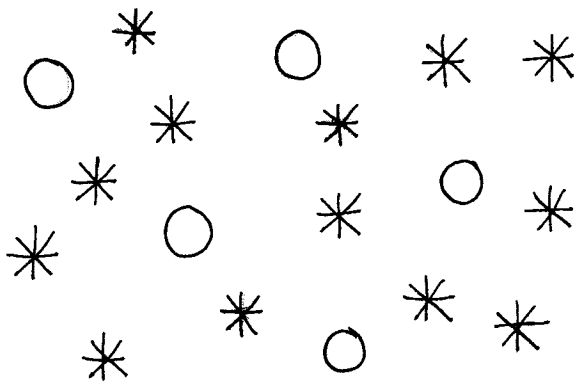

snow

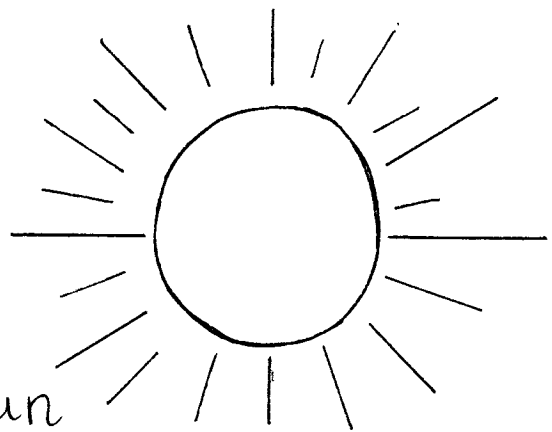

sun

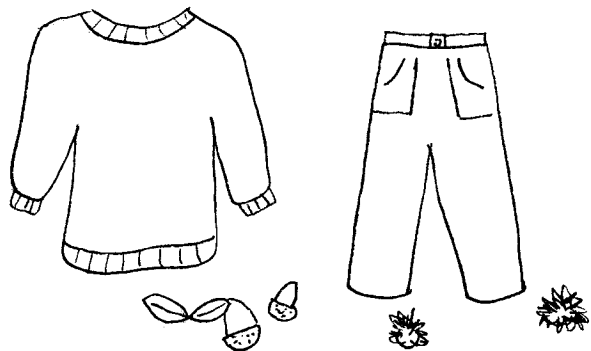
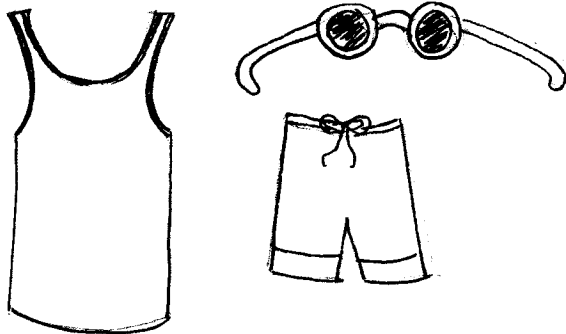
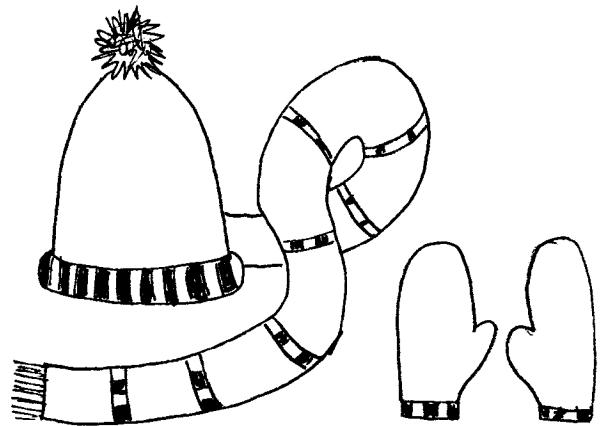
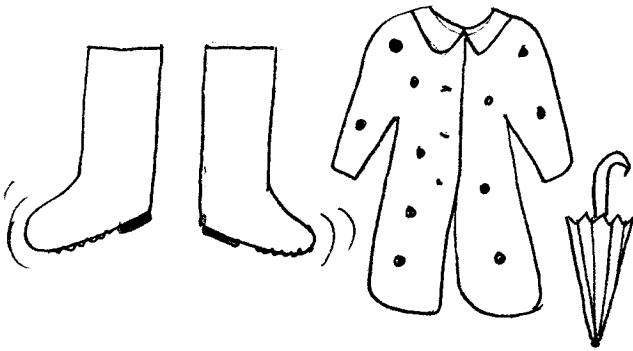

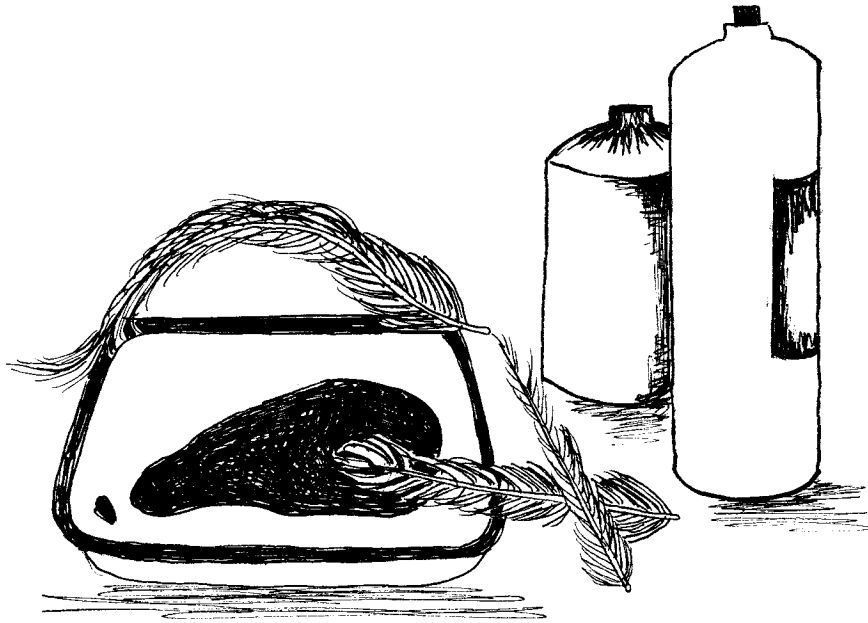

(13)

Changes.

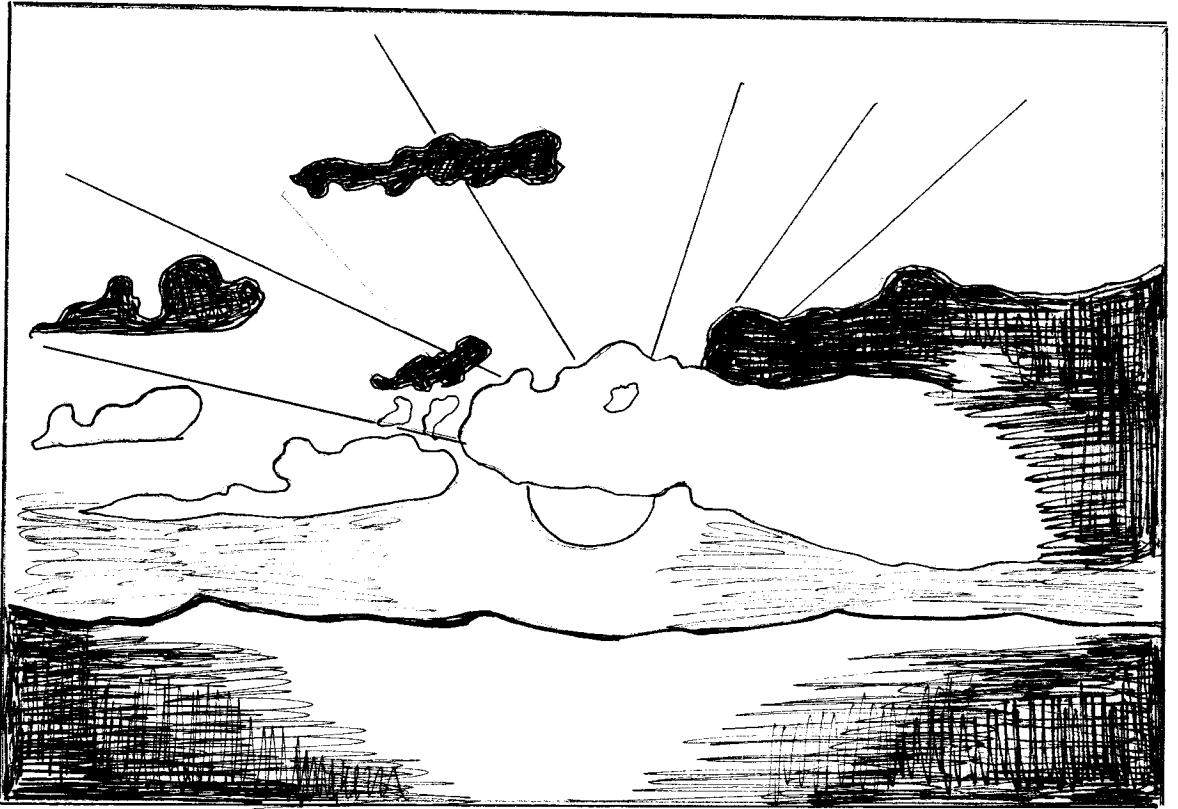

sunset

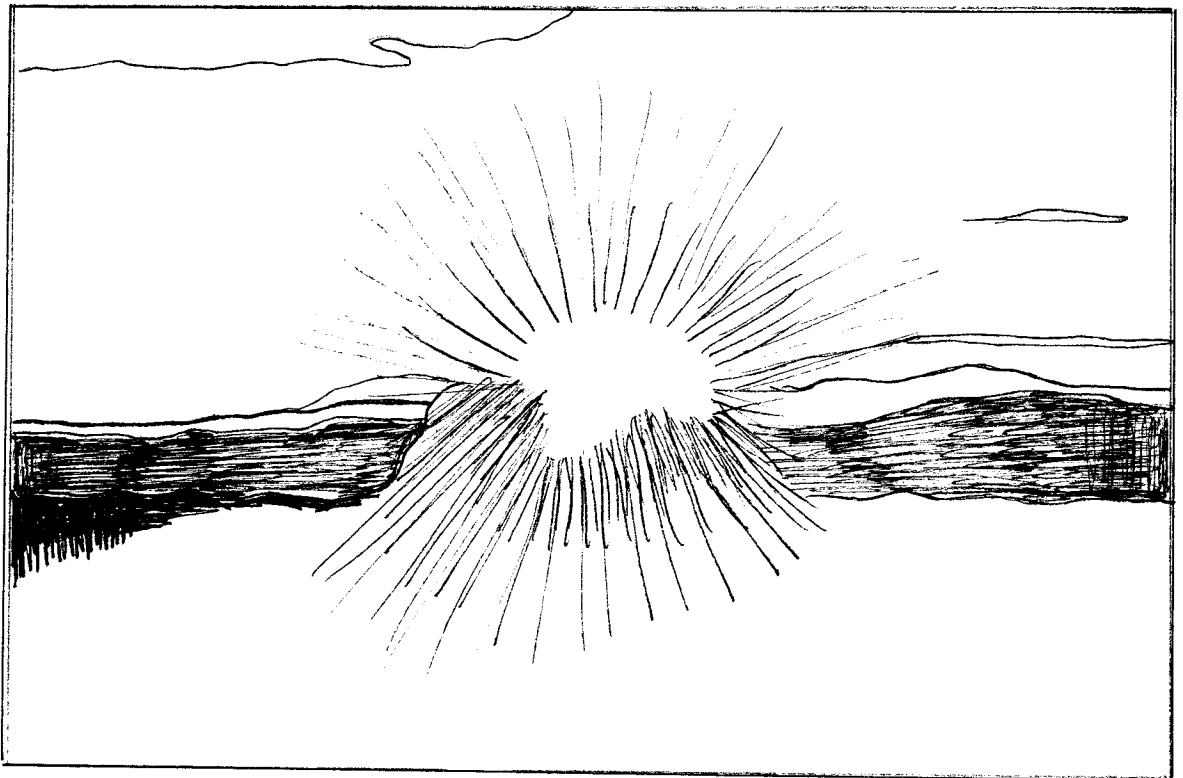

sunrise



15
changes

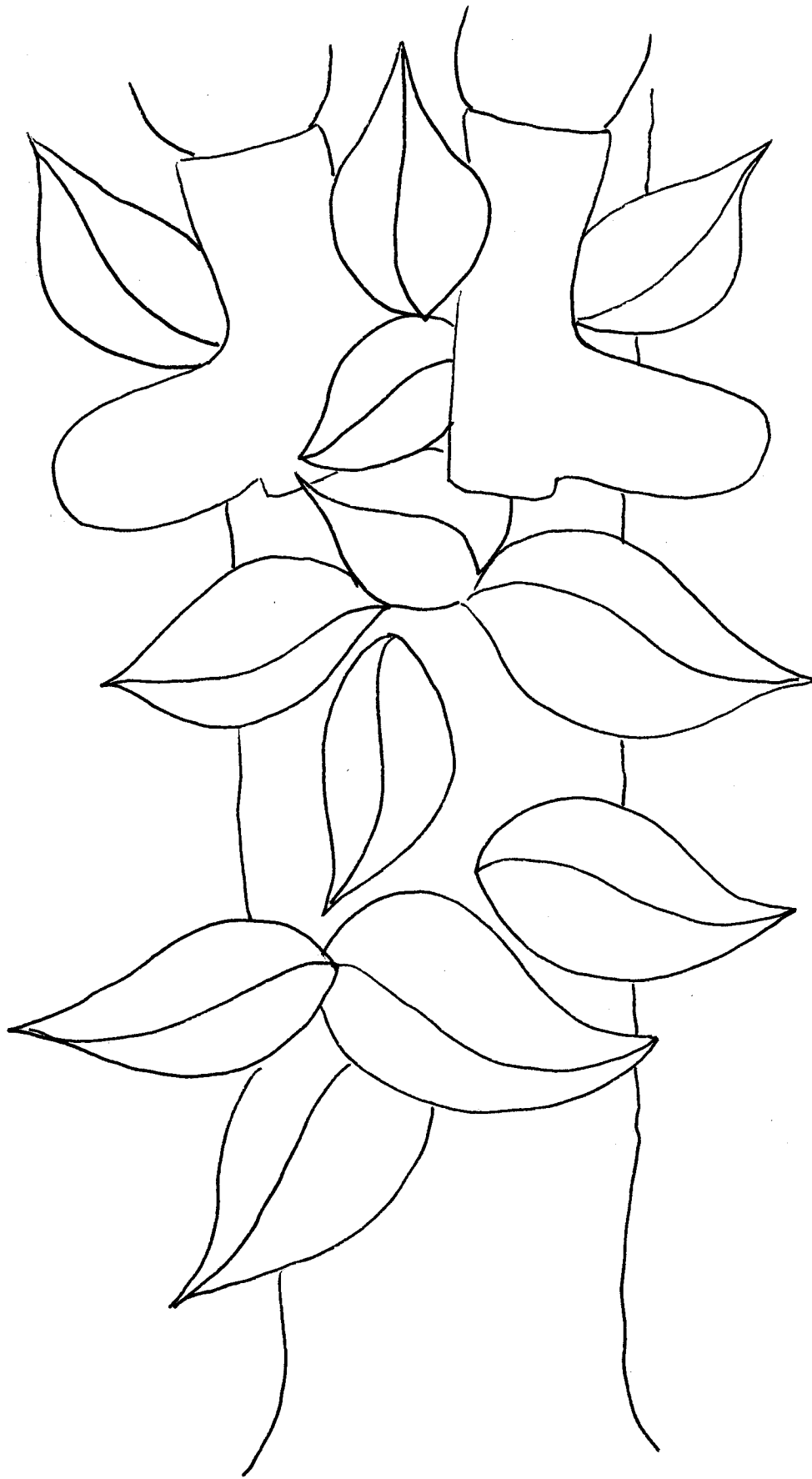

Displays
Jack & the Beanstalk,

Changes (16)